

Allied
Interior
Solutions

Experience the Difference



ALLIED INTERIOR SOLUTIONS
CABINET OPTIONS

Framed Cabinetry

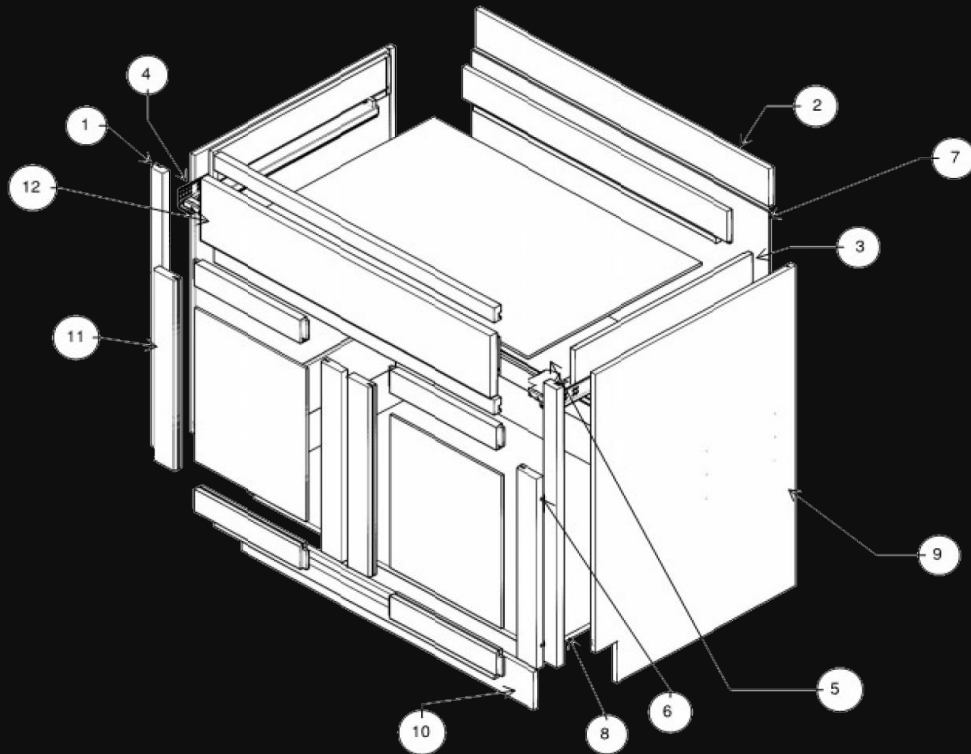

BASE CABINET

1. 3/4" face frame
2. 1/2" nailer
3. 1/2" drawer box
4. Drawer guides, undermount full ext shown.
5. 5/8" thick 10" deep adjustable shelf
Or 3/4" thick full depth adjustable shelf
6. Soft close hinges.
7. 1/8" back panel.
8. 1/2" bottom.
9. 1/2" end panel.
10. 1/2" toekick
11. 3/4" door.
12. 3/4" slab or 5 pc drawer front.

Shaker Style

WOOD FINISH (Framed)

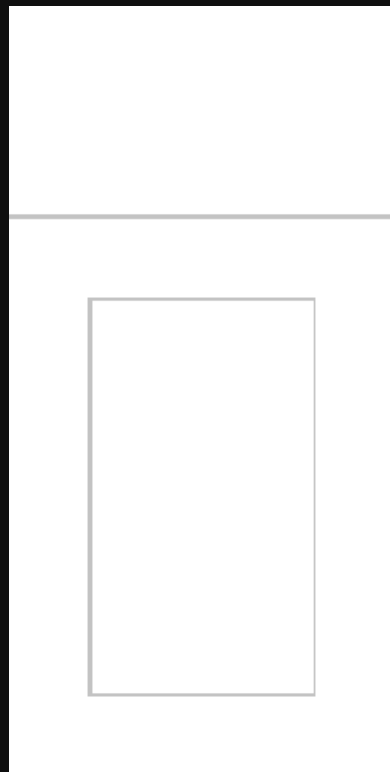

Breeze Shaker

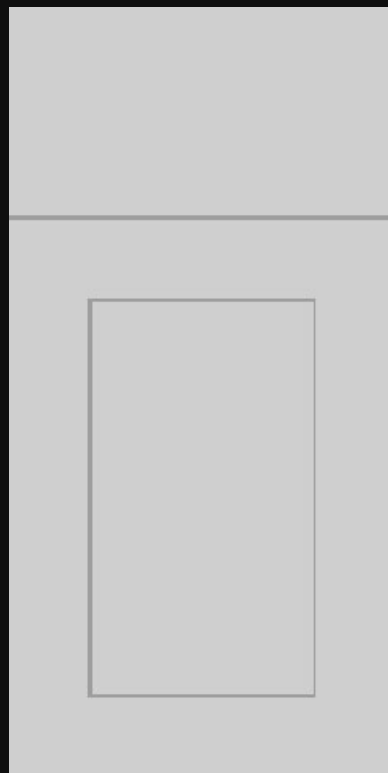

Pebble Shaker

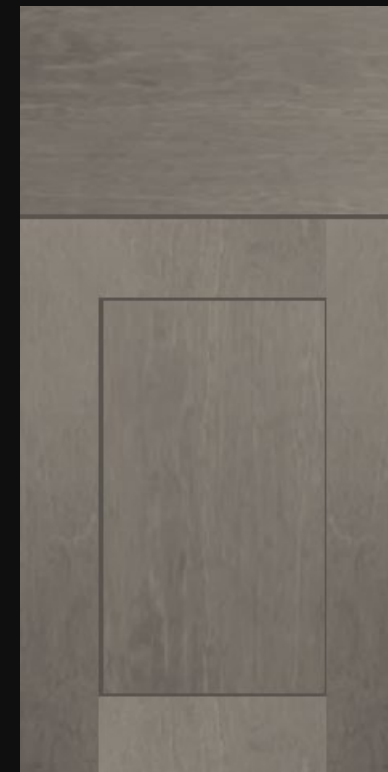

Ash Shaker



* Colors pictured may not reflect in exact in person color. Please request a color sample from sales.

Frameless Cabinetry

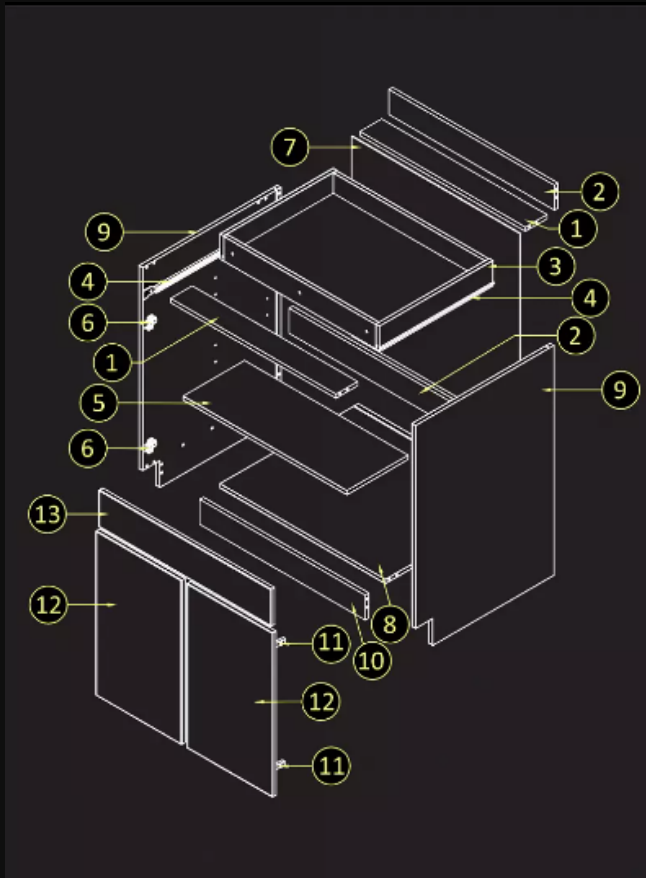

BASE CABINET

1. 5/8" stretcher
2. 5/8" nailer
3. 5/8" drawer box with 1/4" bottom
4. Epoxy Drawer Guides (available to upgrade to under-mount soft close drawer guides)
5. 5/8" thick adjustable shelf
6. Hinge mount base plate
7. 1/8" back panel
8. 5/8" bottom
9. 5/8" end panel
10. 5/8" toe-kick
11. Soft Close Hinges
12. 5/8" door
13. 5/8" drawer front

Cambridge Style

Melamine FINISH (Frameless)



Shown in
Cross Cut Bourbon

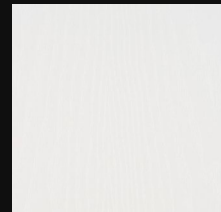

Cotton

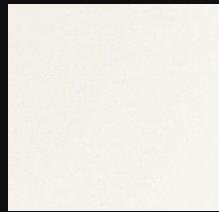

Ivory Oak



Alabaster Elm



Perfectly Natural

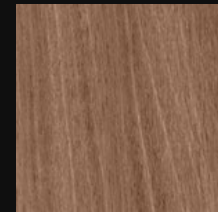

Cross Cut Bourbon



Ebony Oak



* Colors pictured may not reflect in exact in person color. Please request a color sample from sales.

Oxford Style

THERMOFOIL FINISH (Frameless)



Shown in
Southern Basswood

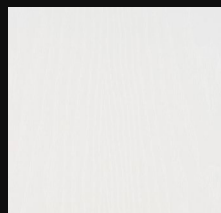

Cotton

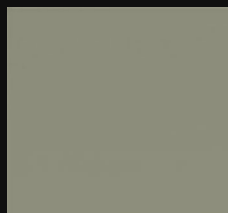

Rhapsody

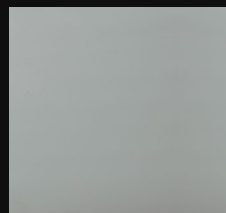

Serenity

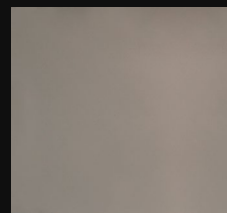

Polaris

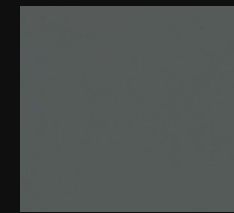

Wrought Iron

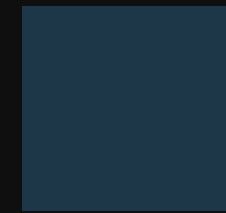

Deep Blue Sea

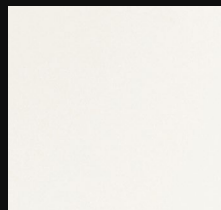

Ivory Oak

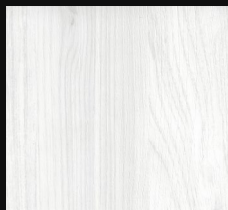

Alabaster Elm

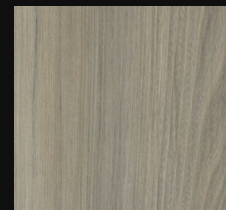

Campania

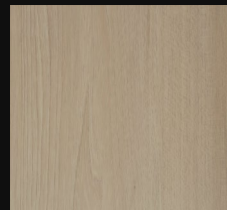

Perfectly Natural

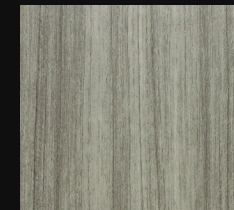

Argentina Grey

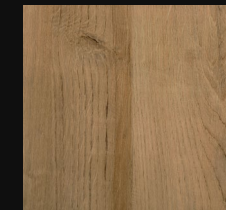

Southern Basswood



Guitar

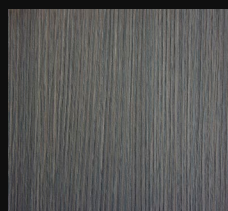

Early Fall

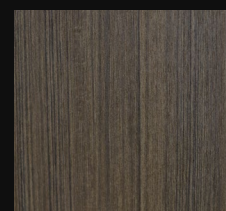

Umbria



Chicory

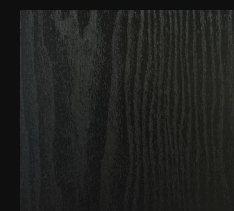

Ebony Oak



Velvet Tuxedo

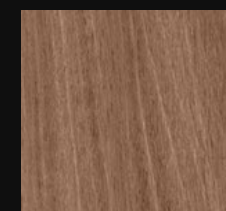

Cross Cut Bourbon



* Colors pictured may not reflect in exact in person color. Please request a color sample from sales.

Manchester Style

THERMOFOIL FINISH (Frameless)



Shown in
Early Fall

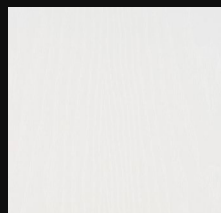

Cotton

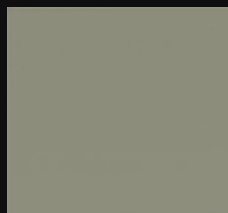

Rhapsody

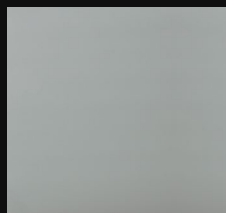

Serenity

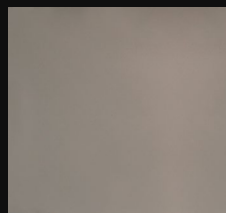

Polaris

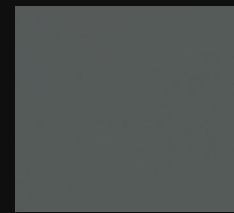

Wrought Iron

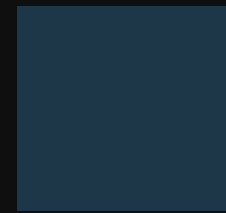

Deep Blue Sea

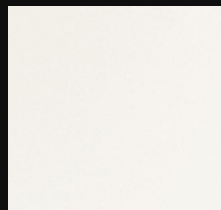

Ivory Oak

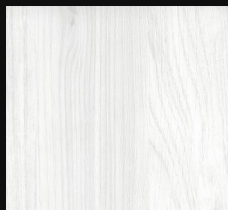

Alabaster Elm

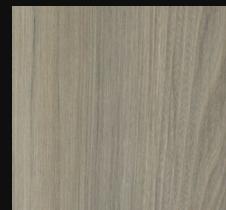

Campania

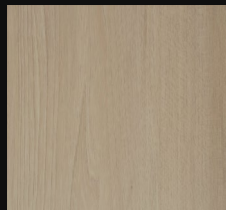

Perfectly Natural



Argentina Grey

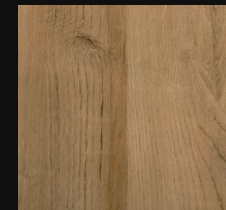

Southern Basswood



Guitar



Early Fall

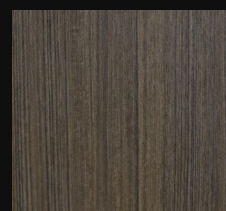

Umbria

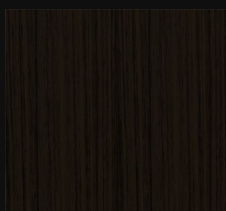

Chicory

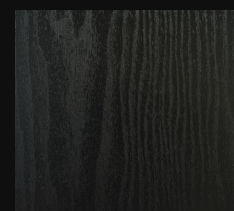

Ebony Oak



Velvet Tuxedo

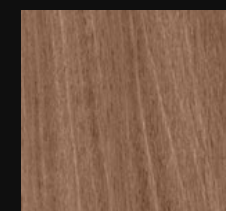

Cross Cut Bourbon



* Colors pictured may not reflect in exact in person color. Please request a color sample from sales.

Bristol Style

THERMOFOIL FINISH (Frameless)

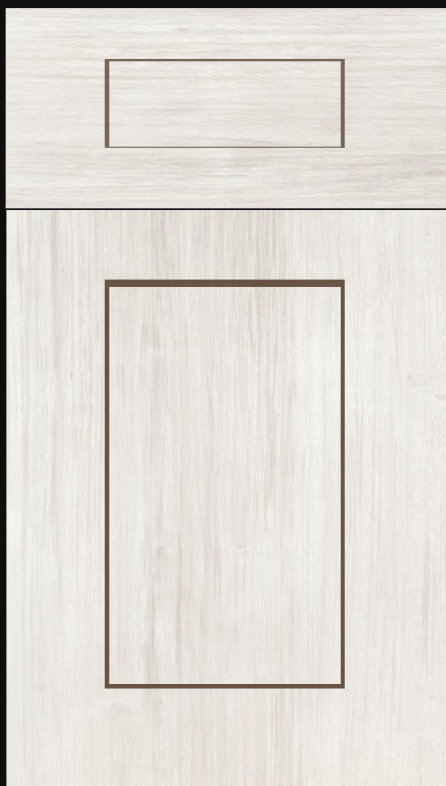

Shown in
Alabaster Elm

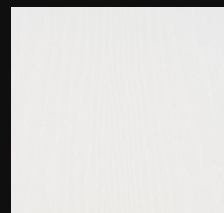

Cotton



Rhapsody

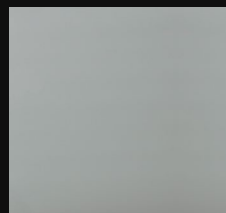

Serenity

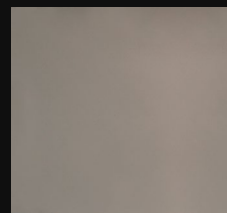

Polaris

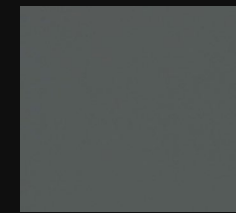

Wrought Iron

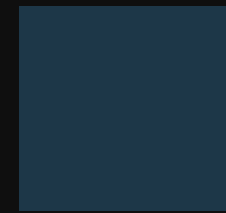

Deep Blue Sea

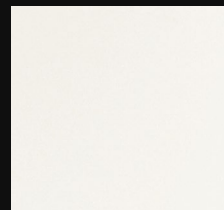

Ivory Oak



Alabaster Elm

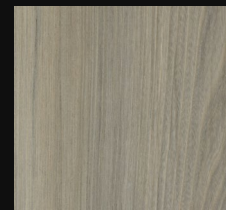

Campania

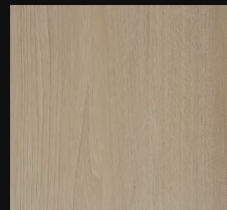

Perfectly Natural

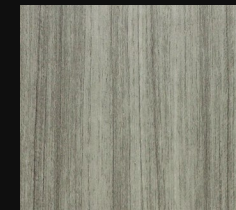

Argentina Grey



Southern Basswood



Guitar

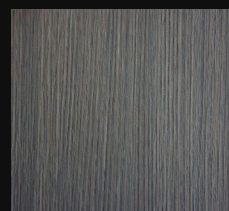

Early Fall

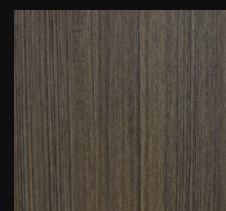

Umbria



Chicory

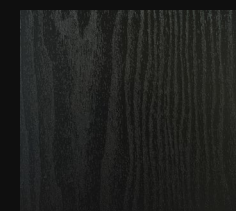

Ebony Oak



Velvet Tuxedo

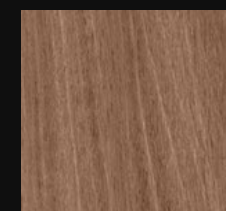

Cross Cut Bourbon



* Colors pictured may not reflect in exact in person color. Please request a color sample from sales.

Touraine Style

THERMOFOIL FINISH (Frameless)



Shown in
Cotton

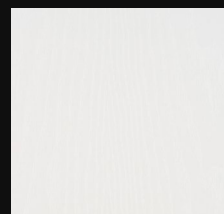

Cotton



Rhapsody

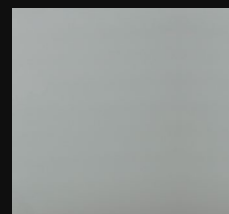

Serenity

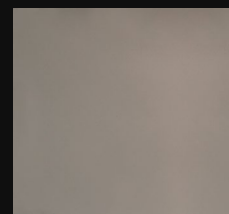

Polaris

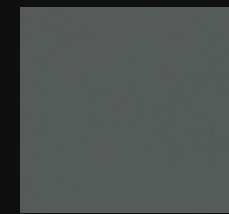

Wrought Iron

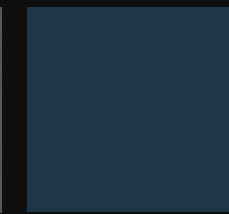

Deep Blue Sea

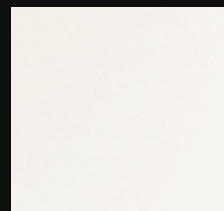

Ivory Oak



Alabaster Elm

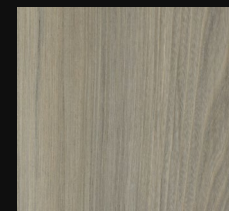

Campania

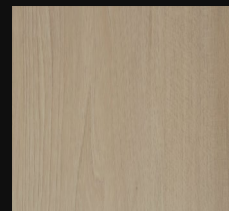

Perfectly Natural

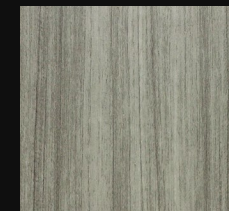

Argentina Grey

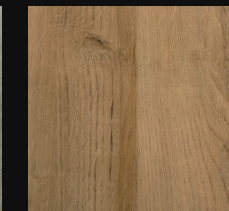

Southern Basswood



Guitar

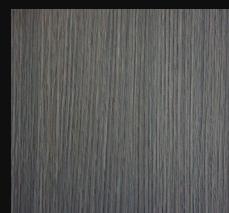

Early Fall

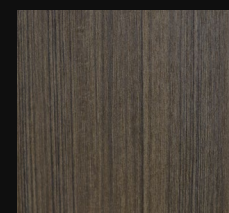

Umbria



Chicory

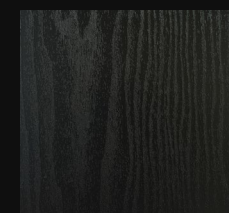

Ebony Oak



Velvet Tuxedo

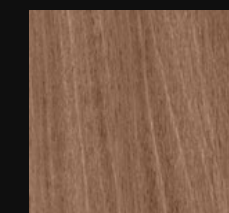

Cross Cut Bourbon



* Colors pictured may not reflect in exact in person color. Please request a color sample from sales.

Brighton Style

THERMOFOIL FINISH (Frameless)



Shown in
Southern Basswood

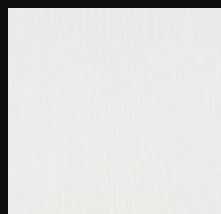

Cotton



Rhapsody

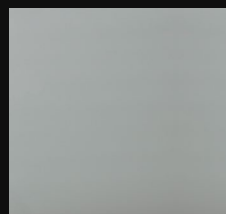

Serenity

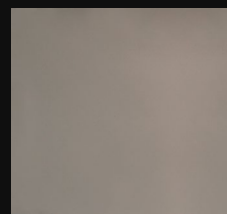

Polaris

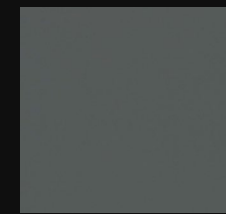

Wrought Iron

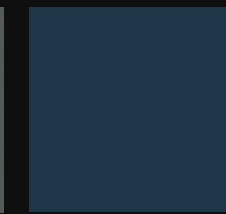

Deep Blue Sea

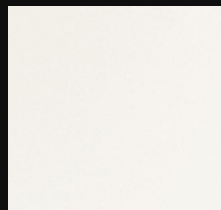

Ivory Oak

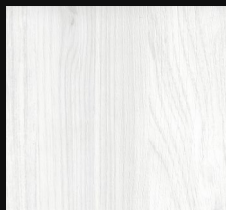

Alabaster Elm

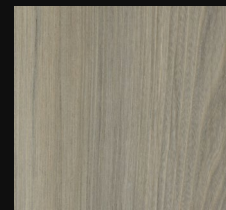

Campania

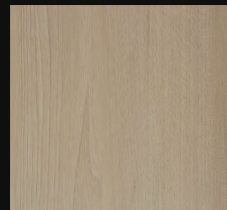

Perfectly Natural

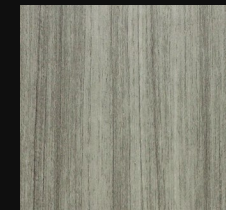

Argentina Grey



Southern Basswood



Guitar

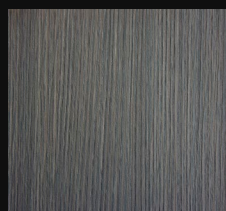

Early Fall

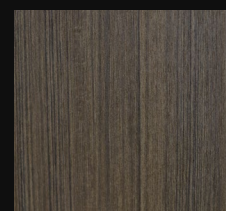

Umbria



Chicory

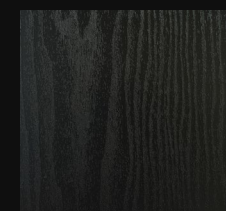

Ebony Oak



Velvet Tuxedo

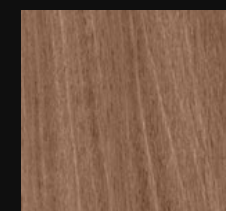

Cross Cut Bourbon



* Colors pictured may not reflect in exact in person color. Please request a color sample from sales.

Allied Interior Solutions

Experience the Difference

